

Writetrack: an inventor's experience

1990: the birth of an idea.

Start this side

Go this way



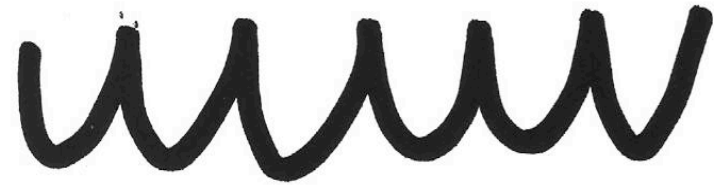
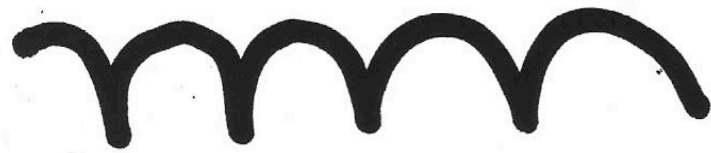
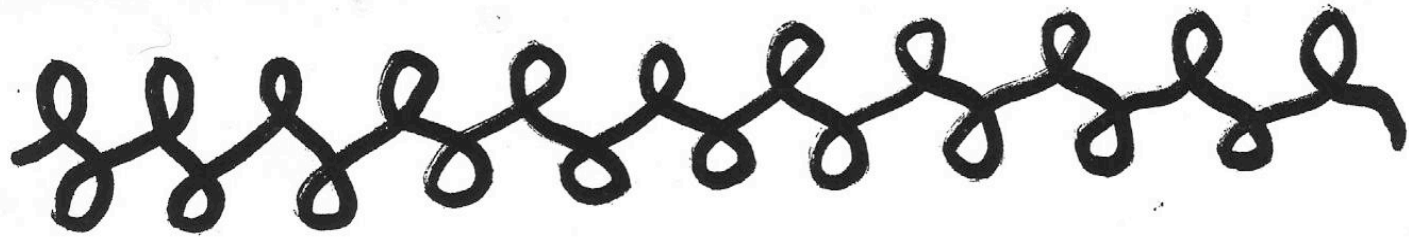

Patent agents and protection.

As it was:

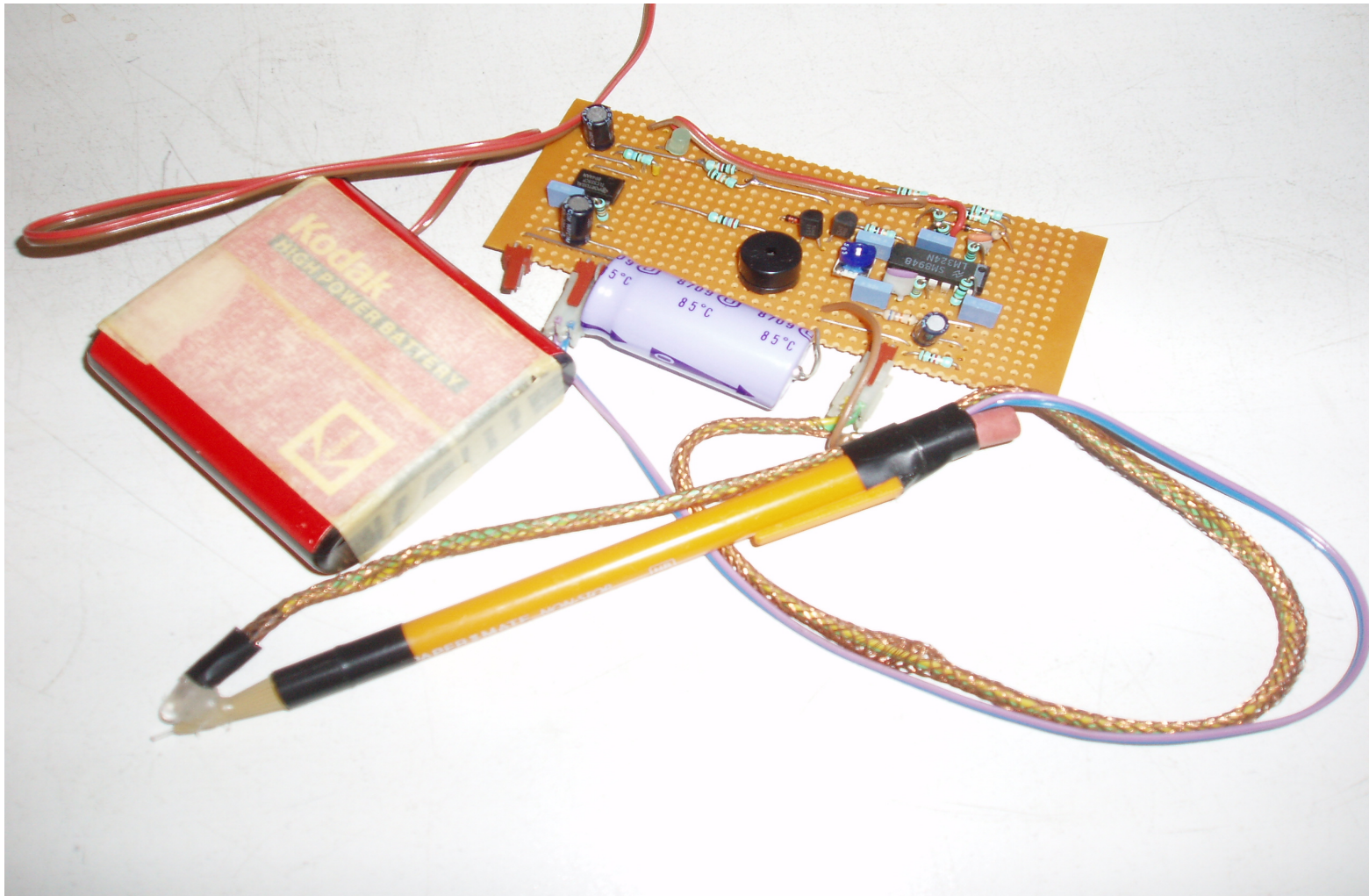

We the undersigned undertake not to reveal any details of the information given in confidence to us by Duncan Louttit this day until the information is placed in the public domain.

30/12/90.

D. A. Nevada 30.12.90
 A.H. Lwista 30.12.90
 W. Rowan 30.12.90
 P. Cooper 31.12.90
 Carol Newell 31.12.90
 J. D. Bird 31.12.90
 P. Cooper 8.1.91
 Carol Newell 9.1.91
 J. D. Bird 14.6.91

J. Atwood 9.1.91.
 S. Patten 9.1.91
 M. Emery 10.1.91.
 V. [unclear] 12.1.91
 Mike [unclear] 13.3.91
 J.S. Louttit 20-3-91
 Helen Louttit 20/3/91
 F. L. Kaul 30/3/91
 G. [unclear] 1/4/91
 J. Bird

WRITE - TRACK

R. Butcher 25.11.91.
 J. Lambert 8.12.91
 P. [unclear] 8.12.91
 J. [unclear] 22.10.92

G. [unclear] 8/12/92.
 J. [unclear] 15/11/94.

“Project X”

2006: at last some time!

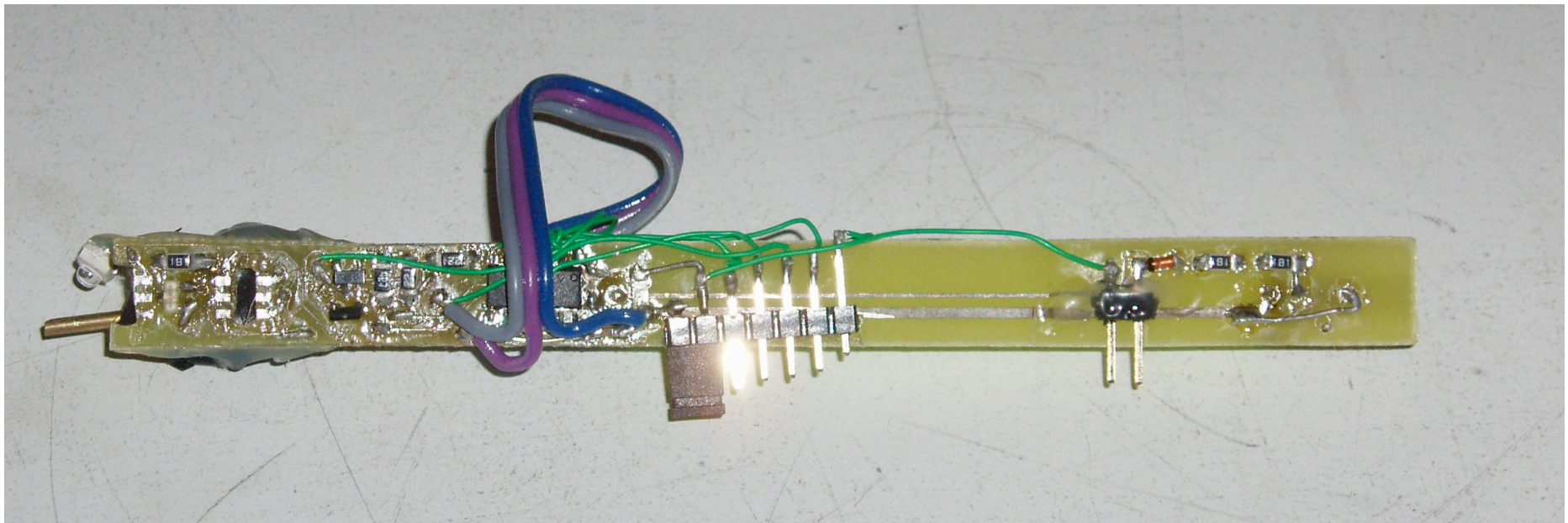

What's it got to do with FORTH?

WriteTrack steup-up convertor & LED driver.
Copyright Duncan Louttit 2009.

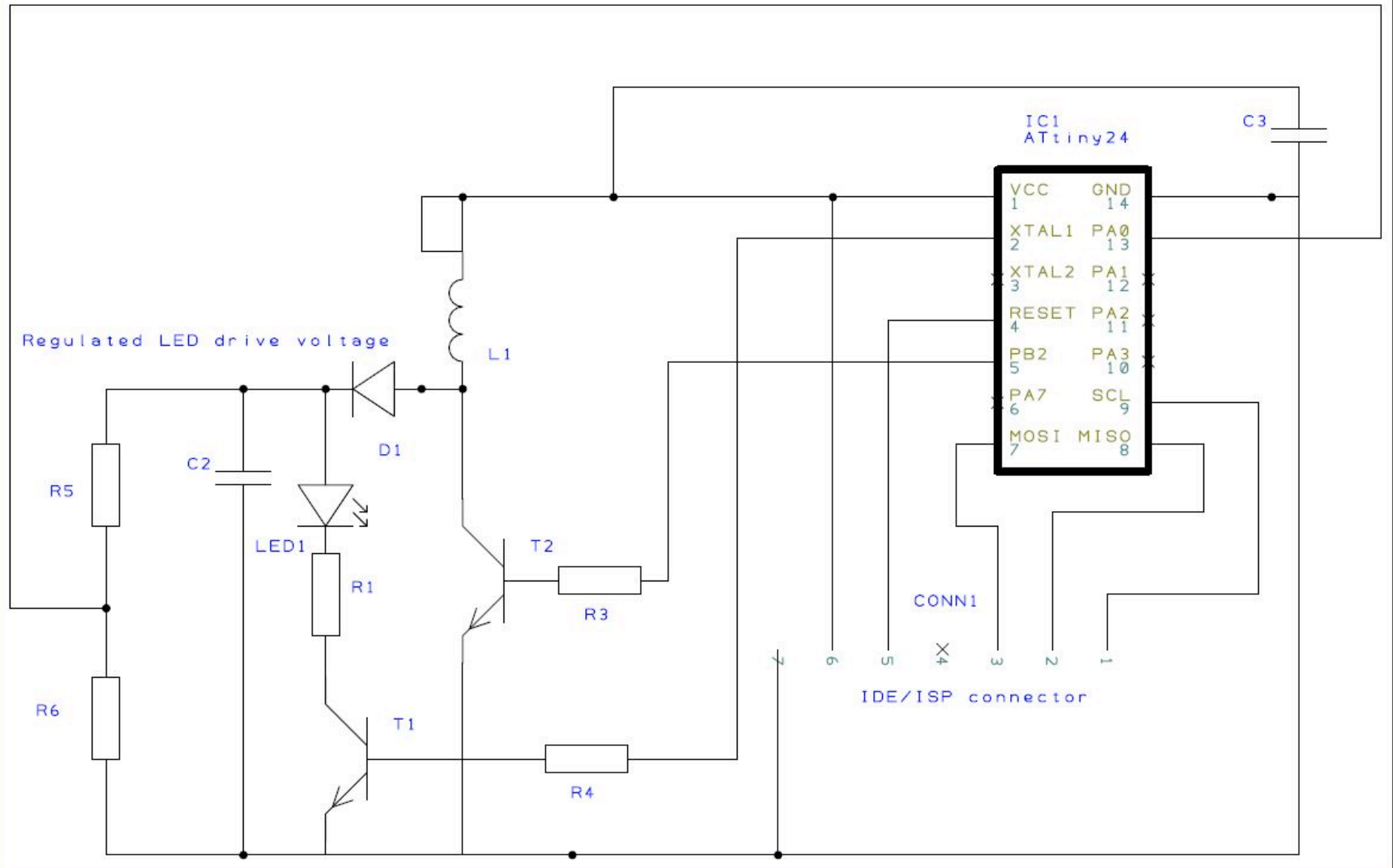

2009: Grant and commercialisation.



INTELLECTUAL
PROPERTY OFFICE

Certificate of Grant of Patent

Patent Number: GB2445030
Proprietor(s): Duncan R Louttit
Inventor(s): Duncan R Louttit

This is to Certify that, in accordance with the Patents Act 1977,

a Patent has been granted to the proprietor(s) for an invention entitled
"Improvements in graphic recognition devices" disclosed in an
application filed **22 December 2006**.

Dated 17 June 2009

Ian Fletcher
Comptroller General of Patents, Designs and Trade Marks
Intellectual Property Office

The attention of the Proprietor(s) is drawn to the important notes overleaf.

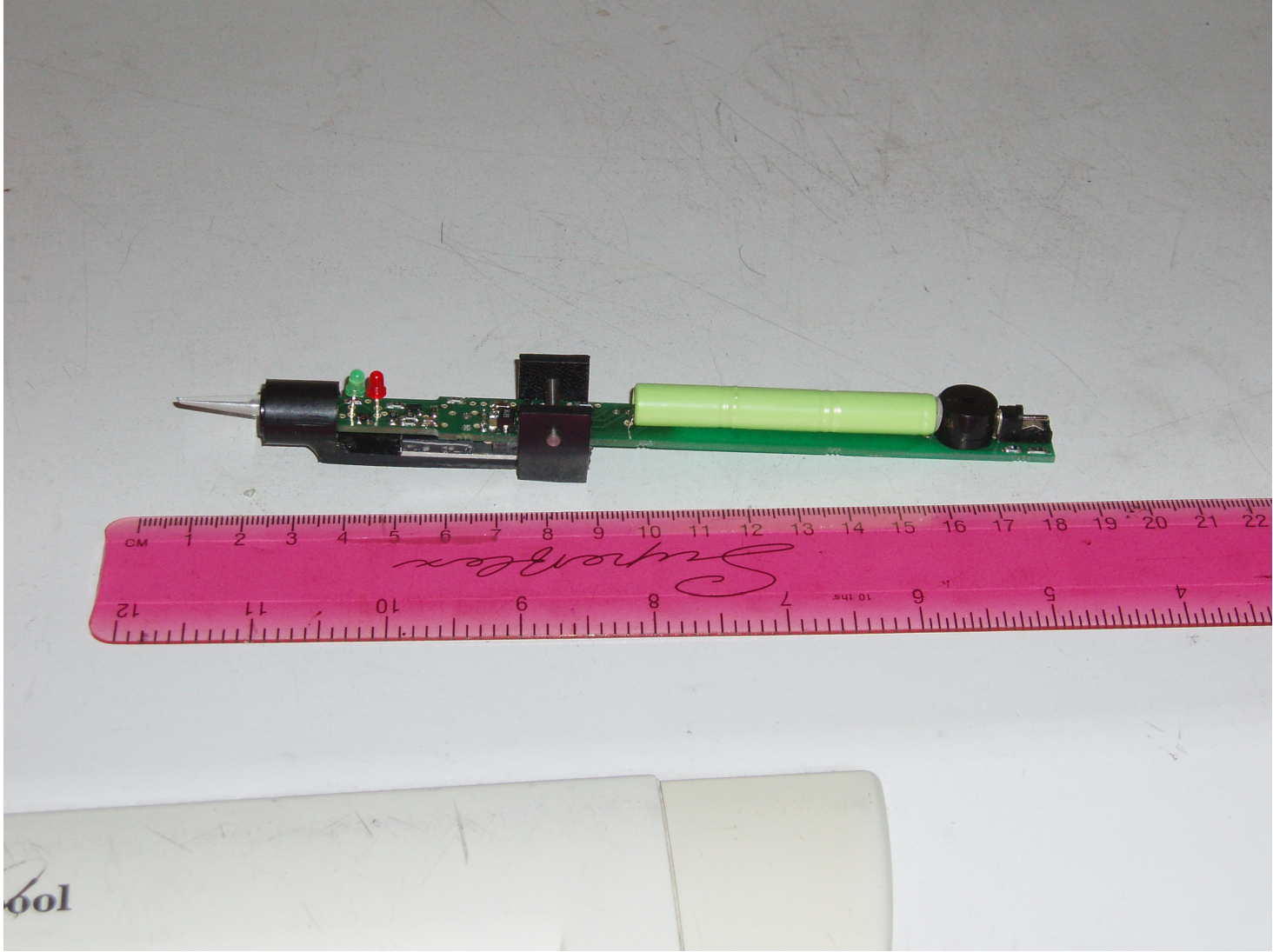

And James?